

# Ecophon Solo™ Freedom

Solo Freedom is a free hanging unit that's possible to design in almost any shape. Create your own unique shapes not found anywhere else or get inspired with Solo Freedom standard shapes; Triangle, Octagon, Heptagon, Hexagon, Pentagon and Ellipse.



Ghalamco Arena, Belgium

## SYSTEM RANGE



Size, mm	1039x1200	1040x1200	1139x1198	1168x1198	Ø1200	1200x1200	2400x1000	2400x1200
Special Fixing	•	•	•	•	•	•	•	•
Thickness (THK)	40	40	40	40	40	40	40	40
Inst. Diagr.	M297	M426	M427	M425	M412	M412	M428	M412

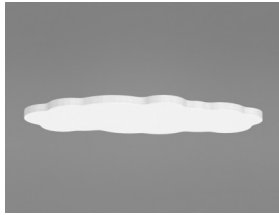

Acoustic panel Solo Freedom in cloud shape

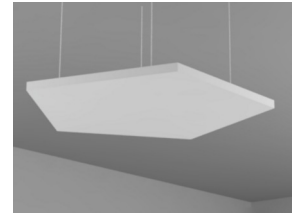
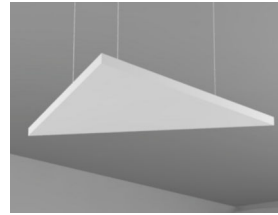
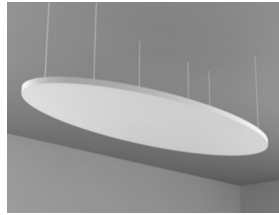

### Acoustic



For acoustic data on the panel - please see Solo Square and Rectangle.

### Indoor Air Quality



Certificate / Label	
Eurofins Indoor Air Comfort®	IAC
French VOC	A
Finnish M1	•



### Environmental Footprint



kg CO <sub>2</sub> equiv/m <sup>2</sup>	
Solo Freedom	8,41 (Solo Family EPD in conformity with ISO 14025 / EN 15804)

Life-cycle stages A1 to C4 from EPD, in conformity with ISO 14025 / EN 15804



### Circularity

Minimum post-consumer recycled content	57%
Recyclability	Fully recyclable



### Fire safety

Country	Class	
Europe	EN 13501-1	A2-s1,d0

The glass wool core of the tiles is tested and classified as non-combustible according to EN ISO 1182.



### Humidity Resistance

Class C, relative humidity 95% and 30°C, according to EN 13964:2014



### Visual appearance

White Frost, nearest NCS colour sample S 0500-N, 85% light reflectance. Gloss < 1.



### Cleanability

Daily dusting and vacuum cleaning. Weekly wet wiping.



### Accessibility

The tiles are demountable.



## Installation

---

Installed according to installation diagrams, installation guides and drawing aid. For information regarding minimum overall depth of system see quantity specification.



## Mechanical properties

---

The tile can take both point loads and distributed loads. See Functional demands, Mechanical properties at [www.ecophon.com](http://www.ecophon.com).



## CE

---

Ecophon ceiling systems are CE marked according to the European harmonized standard EN13964:2014. CE marked construction products are covered by a Declaration of Performance (DOP) which enables customers and users to easily compare performance of products available on the European market.

## INSTALLATION DIAGRAM (M412) FOR ECOPHON SOLO FREEDOM

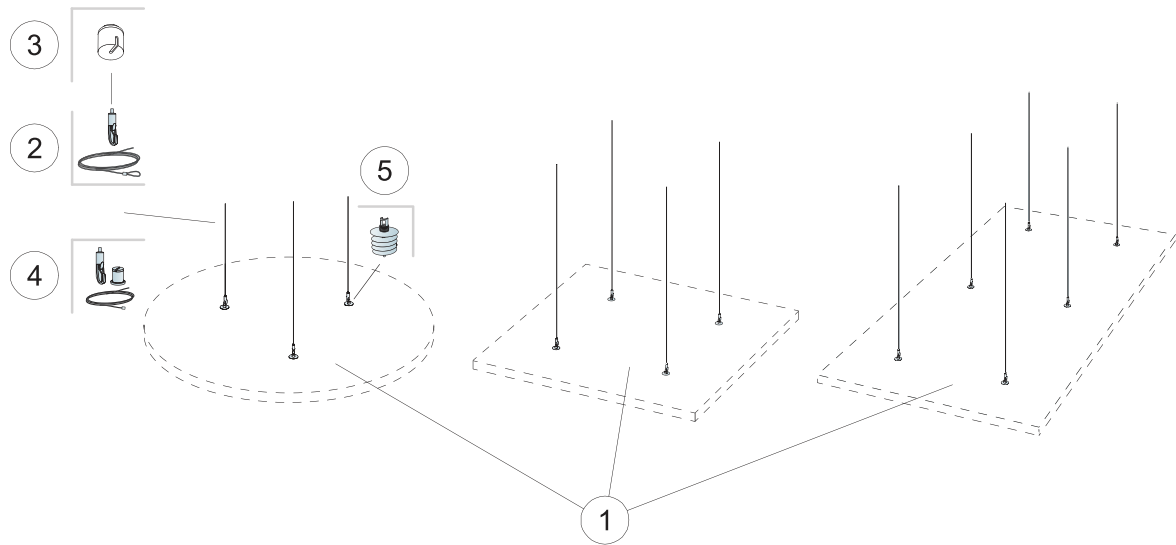

### QUANTITY SPECIFICATION (EXCL. WASTAGE)

		Size, mm		
		Ø1200	1200x1200	2400x1200
1	Solo Freedom	as required	as required	as required
2	Connect Adjustable wire hanger (Alt 1)	3/panel	4/panel	6/panel
3	Connect Covering cup (Alt 1, Optional)	3/panel	4/panel	6/panel
4	Connect Adjustable wire kit (Optional)	3/panel	4/panel	6/panel
5	Connect Absorber anchor	3/panel	4/panel	6/panel
Δ Min. overall depth of system: 140 mm		-	-	-

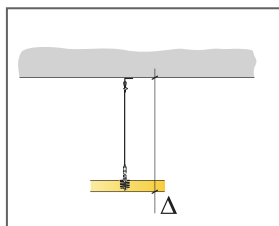

See Quantity specification

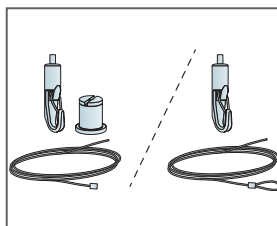

Two types of Adjustable wire solutions

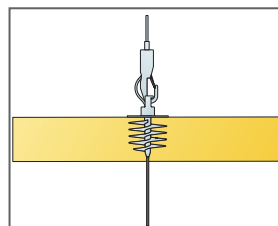

Panels can be suspended underneath each other

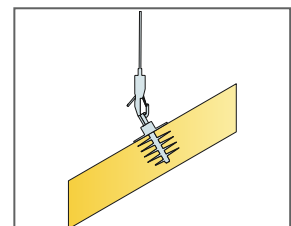

Panels can be installed in angles

## INSTALLATION DIAGRAM (M425) FOR ECOPHON SOLO HEPTAGON

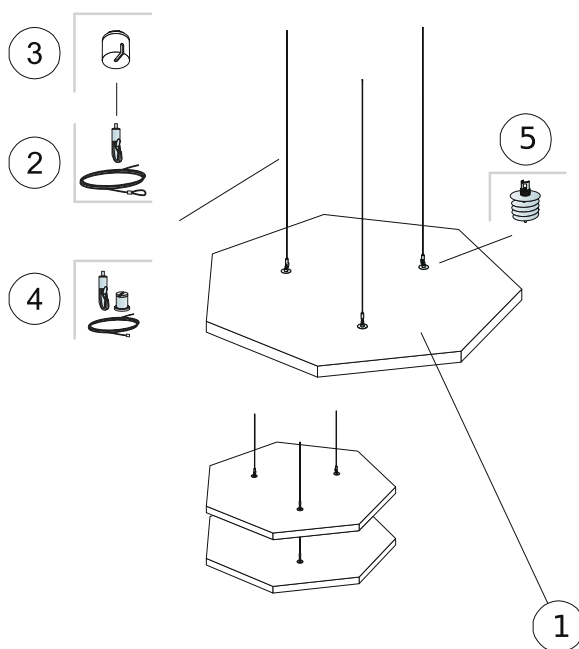

### QUANTITY SPECIFICATION (EXCL. WASTAGE)

		Size, mm
		<b>1168x1198</b>
1	Solo Heptagon	1,03m <sup>2</sup> /panel
2	Connect Adjustable wire hanger (Alt 1)	3/panel
3	Connect Covering cup (Alt 1, Optional)	3/panel
4	Connect Adjustable wire Kit (Alt 1, Optional)	3/panel
5	Connect Absorber anchor (Alt 1)	3/panel
Δ Min. overall depth of system: 140 mm		-
To install Connect Absorber Anchor, use Connect Absorber Anchor Bit.		-

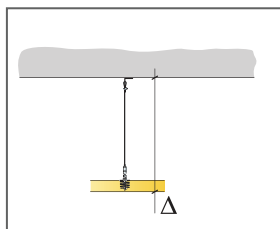

See Quantity specification

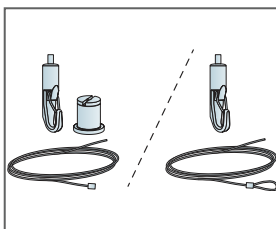

Two types of Adjustable wire solutions

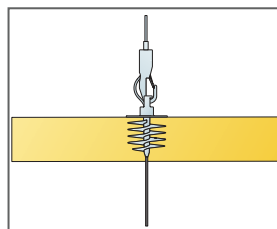

Panels can be suspended underneath each other

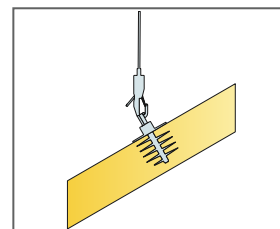

Panels can be installed in angles

## INSTALLATION DIAGRAM (M426) FOR ECOPHON SOLO HEXAGON

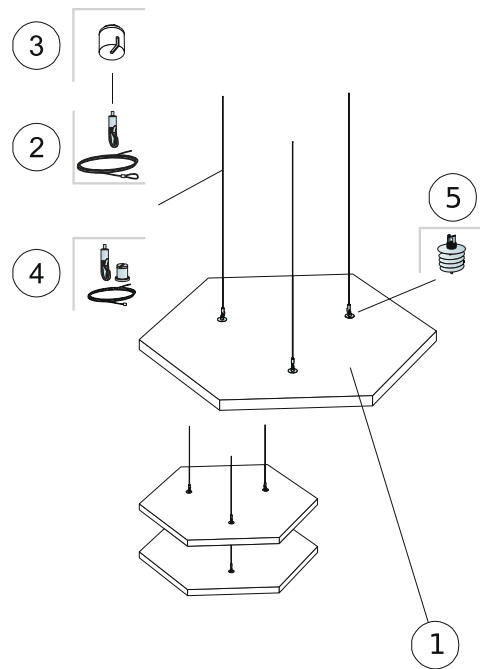

### QUANTITY SPECIFICATION [EXCL. WASTAGE]

		Size, mm
		1040x1200
1	Solo Hexagon	0,94m <sup>2</sup> /panel
2	Connect Adjustable wire hanger (Alt 1)	3/panel
3	Connect Covering cup (Alt 1, Optional)	3/panel
4	Connect Adjustable wire Kit (Alt 1, Optional)	3/panel
5	Connect Absorber anchor (Alt 1)	3/panel
Δ Min. overall depth of system: 140 mm		-
To install Connect Absorber Anchor, use Connect Absorber Anchor Bit.		-

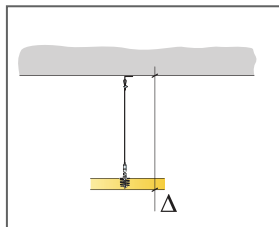

See Quantity specification

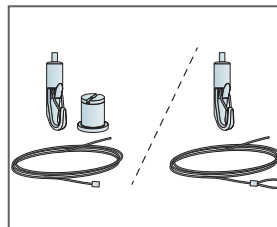

Two types of Adjustable wire solutions

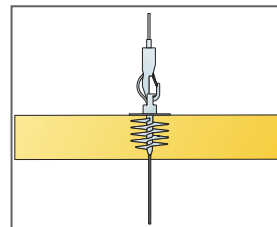

Panels can be suspended underneath each other

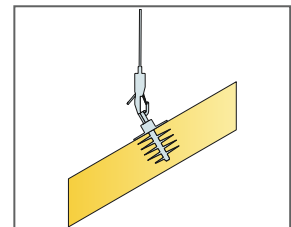

Panels can be installed in angles

## INSTALLATION DIAGRAM (M427) FOR ECOPHON SOLO PENTAGON

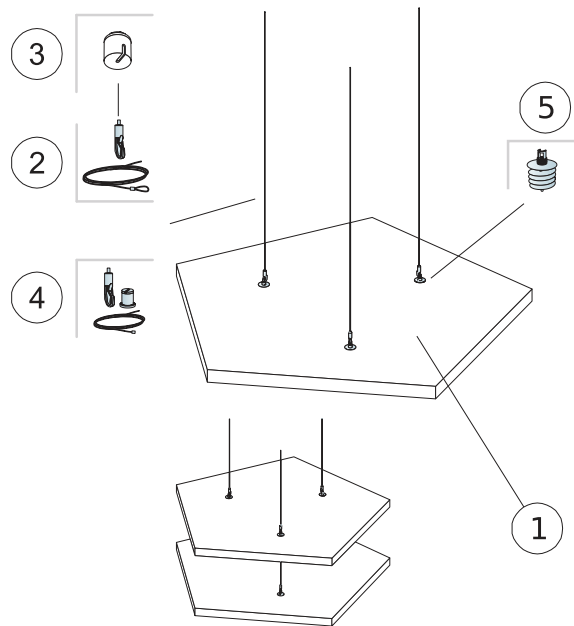

### QUANTITY SPECIFICATION (EXCL. WASTAGE)

		Size, mm
		1139x1198
1	Solo Pentagon	0,94m <sup>2</sup> /panel
2	Connect Adjustable wire hanger (Alt 1)	3/panel
3	Connect Covering cup (Alt 1, Optional)	3/panel
4	Connect Adjustable wire Kit (Alt 1, Optional)	3/panel
5	Connect Absorber anchor (Alt 1)	3/panel
Δ Min. overall depth of system: 140 mm		-
To install Connect Absorber Anchor, use Connect Absorber Anchor Bit.		-

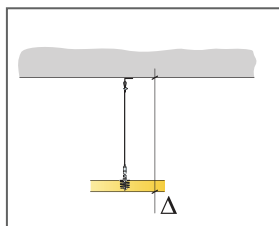

See Quantity specification

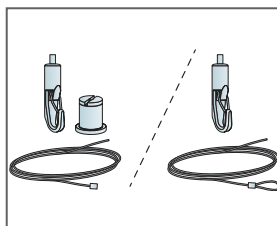

Two types of Adjustable wire solutions

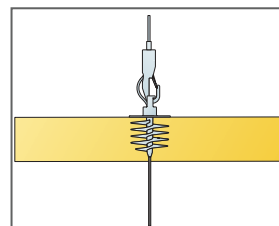

Panels can be suspended underneath each other

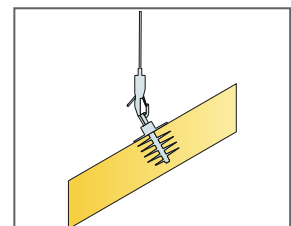

Panels can be installed in angles

## INSTALLATION DIAGRAM (M428) FOR ECOPHON SOLO ELLIPSE

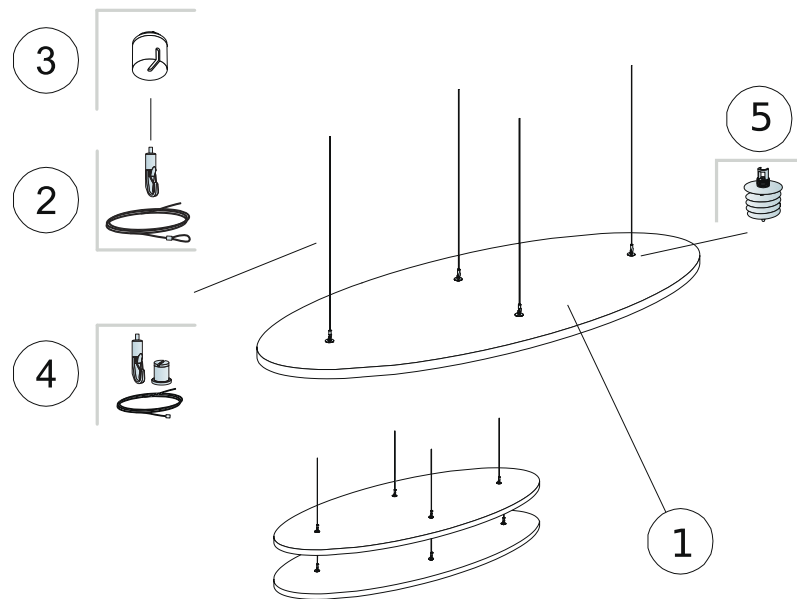

### QUANTITY SPECIFICATION (EXCL. WASTAGE)

		Size, mm
		<b>2400x1000</b>
1	Solo Ellipse	1,89m <sup>2</sup> /panel
2	Connect Adjustable wire hanger (Alt 1)	4/panel
3	Connect Covering cup (Alt 1, Optional)	4/panel
4	Connect Adjustable wire kit (Alt 1, Optional)	4/panel
5	Connect Absorber anchor (Alt 1)	4/panel
Δ Min. overall depth of system: 140 mm		-
To install Connect Absorber Anchor, use Connect Absorber Anchor Bit.		-

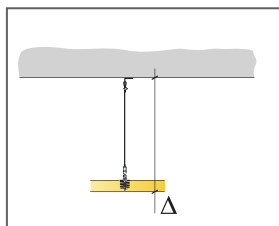

See Quantity specification

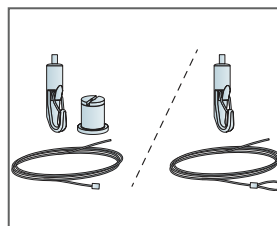

Two types of Adjustable wire solutions

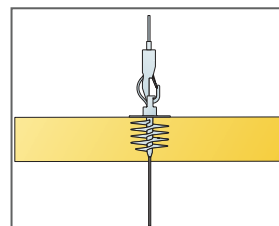

Panels can be suspended underneath each other

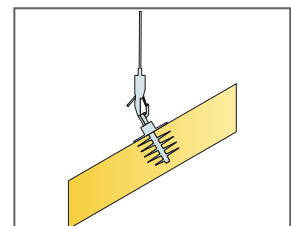

Panels can be installed in angles



## INSTALLATION DIAGRAM (M297) FOR ECOPHON SOLO TRIANGLE

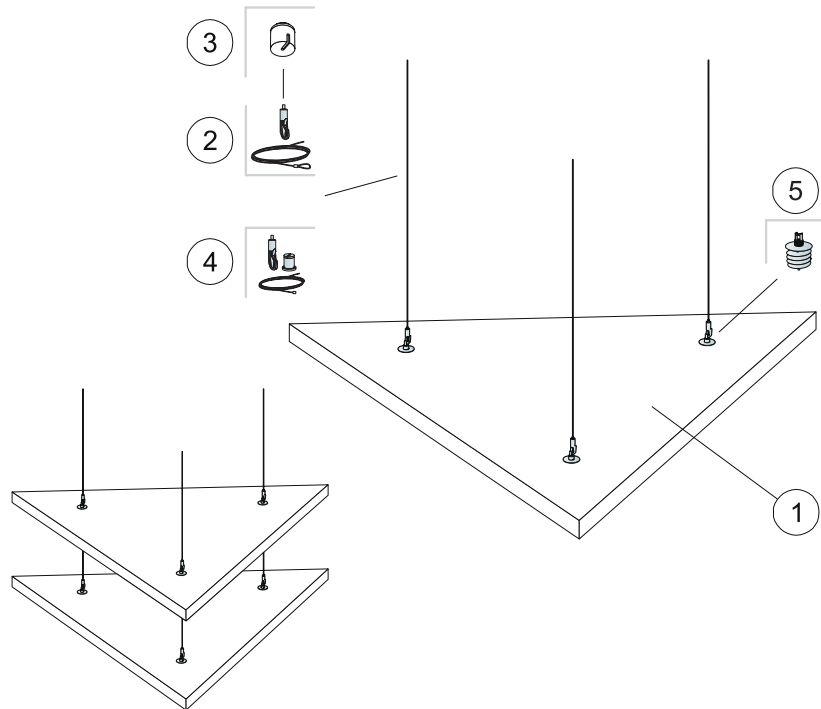

### QUANTITY SPECIFICATION (EXCL. WASTAGE)

		Size, mm
		1039x1200
1	Solo Triangle	0,62m <sup>2</sup> /panel
2	Connect Adjustable wire hanger	3/panel
3	Connect Covering cup (Optional)	3/panel
4	Connect Adjustable wire Kit (Alt 1, Optional)	3/panel
5	Connect Absorber anchor	3/panel
Δ Min. overall depth of system: 140 mm		-
To install Connect Absorber Anchor, use Connect Absorber Anchor Bit.		-

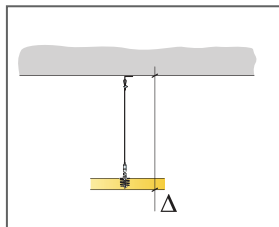

See Quantity specification

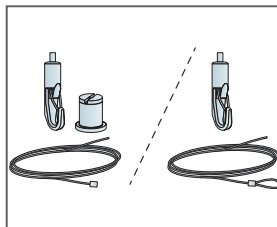

Two types of Adjustable wire solutions

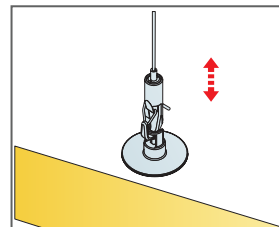

Easily adjustable suspension with Connect Adjustable wire hanger

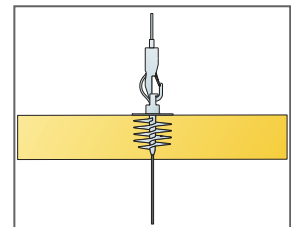

Panels can be suspended underneath each other