



Ecophon Combison™ A, dB 42

Ecophon Combison™ dB is the fastest and easiest way to combine features for both sound absorption and sound insulation between rooms. Ideal for installations where the partitions do not extend all the way up to the soffit. Combison dB can also help to reduce vertical noise from floor to floor. The panel is easy to handle, install and demount and it has a visible grid system. It is made from crimped glass fibre and has an Akutex FT surface on the front.



SYSTEM RANGE

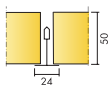

Size, mm	600x600	1200x600
T24	•	•
Thickness (THK)	50	50
Inst. Diagr.	M531	M531

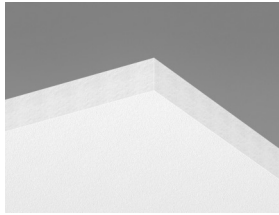

Combison A dB 42 tile

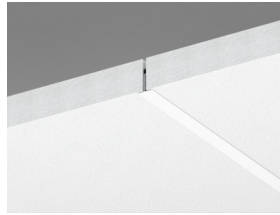

Section of Combison A dB 42 system



Combison A dB 42 system

Acoustic



Sound Absorption:

Test results according to EN ISO 354. Classification according to EN ISO 11654.

α_p , Practical sound absorption coefficient

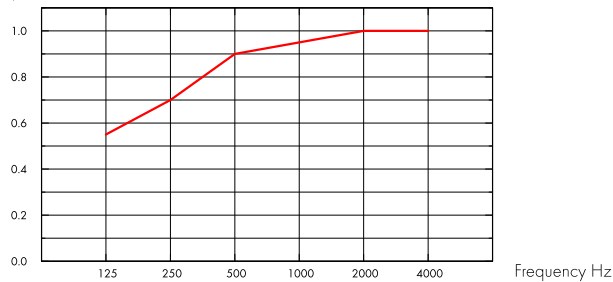

— Combison dB 42 A/E, 200 mm o.d.s.

o.d.s = overall depth of system

THK mm	o.d.s. mm	α_p , Practical sound absorption coefficient						α_w	Sound absorption class
		125 Hz	250 Hz	500 Hz	1000 Hz	2000 Hz	4000 Hz		
50	200	0.55	0.70	0.90	0.95	1.00	1.00	0.95	A

THK mm	o.d.s. mm	NRC	SAA
50	200	0.90	0.90

THK mm	Product	D_{nfw}	R_w
		Weighted normalized flanking level difference, ISO 10848-2	Weighted sound reduction index, ISO 10140-2
50	-	42	21
-	+ 1 x Barrier	+4	-
-	+ 2 x Barrier	+8	-
-	+ 2 x 1200 XR	+3	-

Indoor Air Quality



Certificate / Label	
French VOC	A
Finnish M1	•



Environmental Footprint



	kg CO ₂ equiv/m ²
Combison A dB 42	8,0

Life-cycle stages A1 to C4 from EPD, in conformity with ISO 14025 / EN 15804



Circularity

Fully recyclable.



Fire safety

Country	Class
Europe	EN 13501-1 A2-s1,d0

The glass wool core of the tiles is tested and classified as non-combustible according to EN ISO 1182.



Humidity Resistance

Class A, relative humidity 70% and 25°C, according to EN 13964:2014



Visual appearance

Akutex FT: White Frost, nearest NCS colour sample S 0500-N, 85% light reflectance. Gloss < 1. For more info see Colours and surfaces.



Cleanability

Akutex FT: Daily dusting and vacuum cleaning. Weekly wet wiping. For more info see Colours and surfaces.



Accessibility

The tiles are easily demountable. Minimum demounting depth according to installation diagrams.



Installation

Installed according to installation diagrams, installation guides and drawing aid. For information regarding minimum overall depth of system see quantity specification.



System weight

The weight of the system (including suspension grid) should be approximately 7 kg/m².



Mechanical properties

See table about Max live load and Min load bearing capacity and Functional demands, Mechanical properties at www.ecophon.com.



CE

Ecophon ceiling systems are CE marked according to the European harmonized standard EN 13964:2014. CE marked construction products are covered by a Declaration of Performance (DOP) which enables customers and users to easily compare performance of products available on the European market.

INSTALLATION DIAGRAM (M531) FOR ECOPHON COMBISON A, DB 42

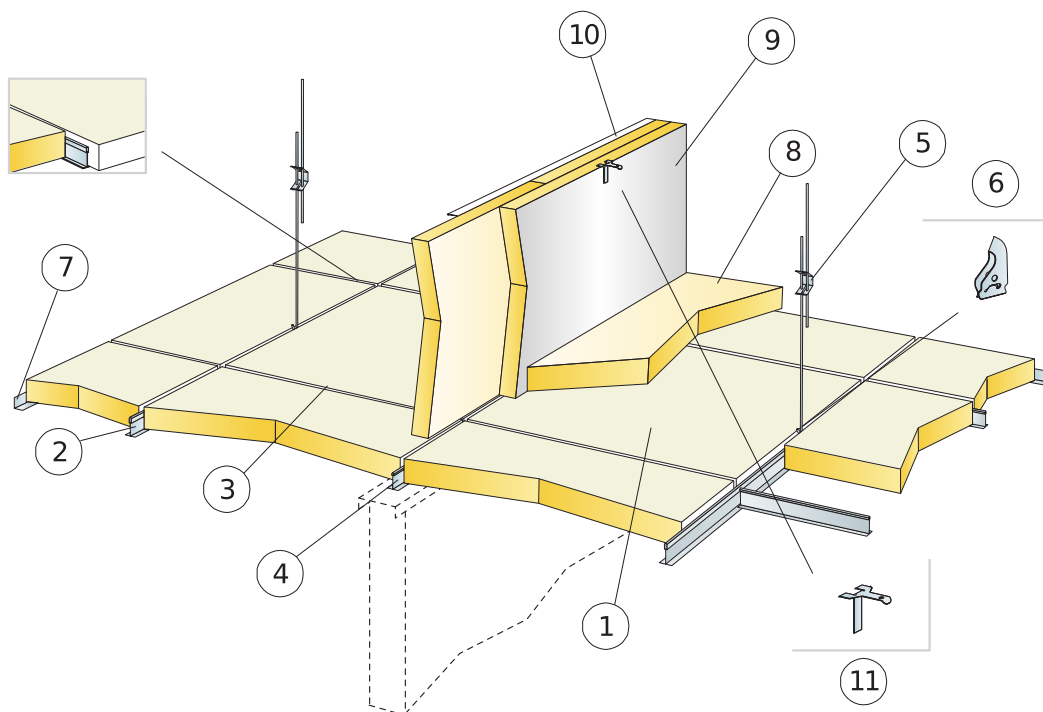

QUANTITY SPECIFICATION (EXCL. WASTAGE)

	Size, mm	
	600x600	1200x600
1 Combison A, dB 42	2,8/m ²	1,4/m ²
2 Connect T24 Main runner, installed at 1200 mm centres (max distance from wall 300 mm)	0,9m/m ²	0,9m/m ²
3 Connect T24 Cross tee, L=1200 mm, installed at 600 mm centres	1,7m/m ²	1,7m/m ²
4 Connect T24 Cross tee, L=600 mm	0,9m/m ²	-
5 Connect Adjustable Hanger, installed at 1200 mm centres (max. distance from wall 600 mm)	0,7/m ²	0,7/m ²
6 Connect Hanger Clip (not to be used in swimming hall environments)	0,7/m ²	0,7/m ²
7 Connect Angle trim, fixed at 200 mm centres	as required	as required
8 Combison XR (if required)	as required	as required
9 Combison Barrier (if required)	as required	as required
10 Connect Angle trims position upper part of Barrier panels (if required)	as required	as required
11 Connect Frieze bracket, position upper part of Barrier panels (if required)	as required	as required
Δ Min. overall depth of system: 100 mm	-	-
δ Min. demounting depth: 210 mm	-	-

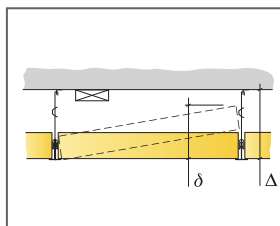

See Quantity specification

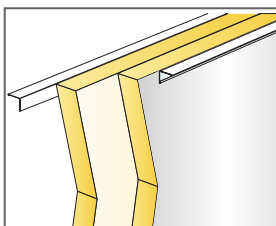

Si il y a deux barrières, la feuille alu doit être à l'extérieur

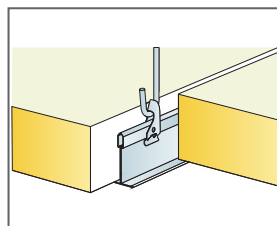

Suspension with adjustable hanger and clip

Size, mm	Max live load (N)	Min load bearing capacity (N)
600x600x50	15	160
1200x600x50	15	160

Live load/load bearing capacity